

Performance improvements with primary key redesign

© 2013 Tieto Corporation

Mikko Larkela

Tieto,
mikko.larkela@tieto.com



Table of contents

- Surrogate key 4-5
- Natural key 6-7
- OLD STRUCTURE 8-10
- NEW STRUCTURE 12-13

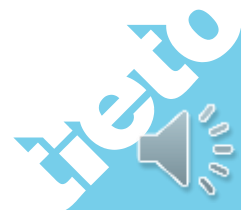

Surrogate key

- The surrogate is internally generated by the system and is invisible to the user or application.
- I'm not the biggest fan of surrogate keys, also I easily get a headache when developers explain that ORM framework and surrogate is fantastic..."it's so easy and fast to implement".



Surrogate key

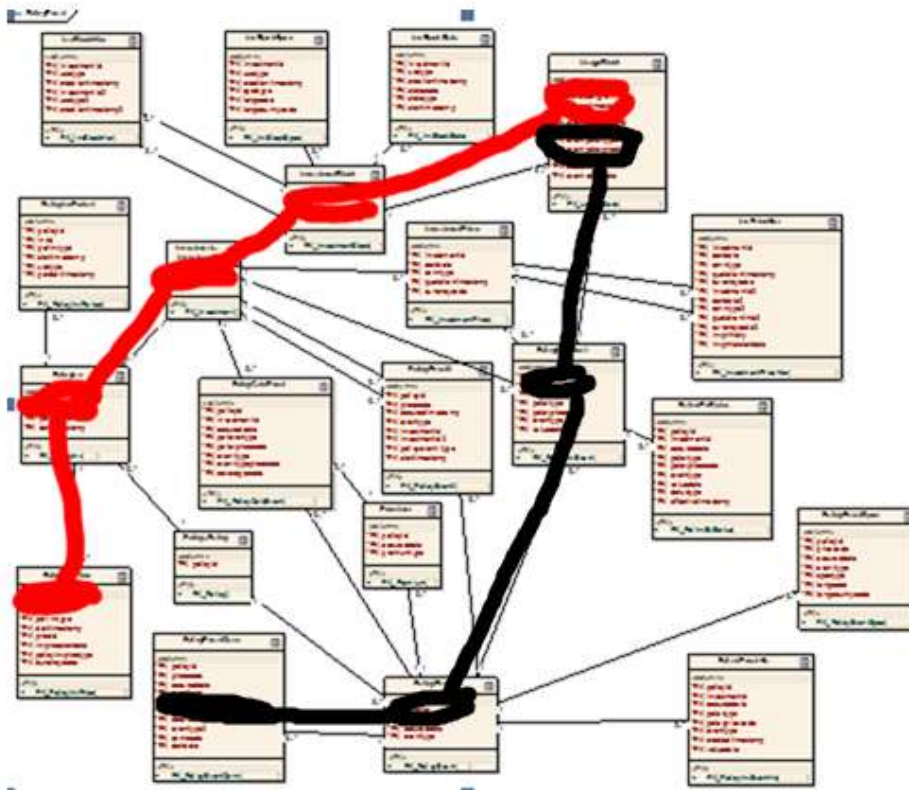

Painful joins

Touches several tables



Natural key

- Is formed of attributes that already exist
- Can avoid duplicates
- Fast access to tables
- Supports well batch processing and reporting
- I'am a natural key fan....



2013-03-02

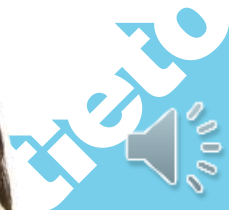

Natural key

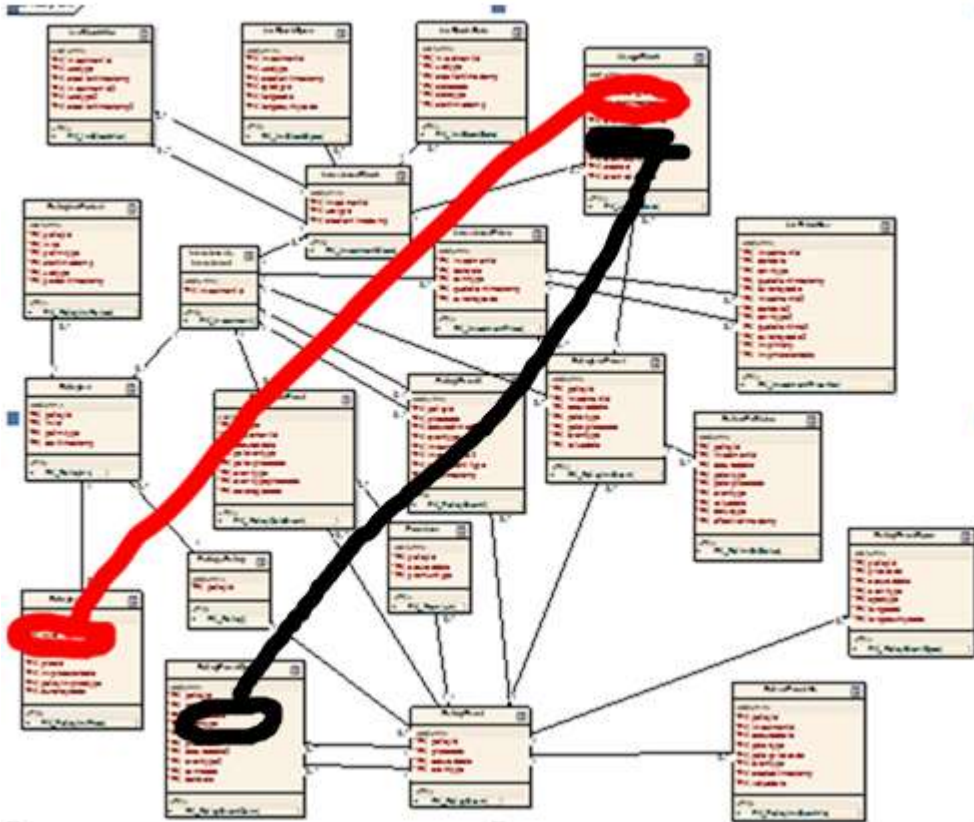

Effective queries

Batch processing!

Reporting!

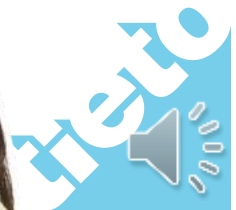

OLD STRUCTURE

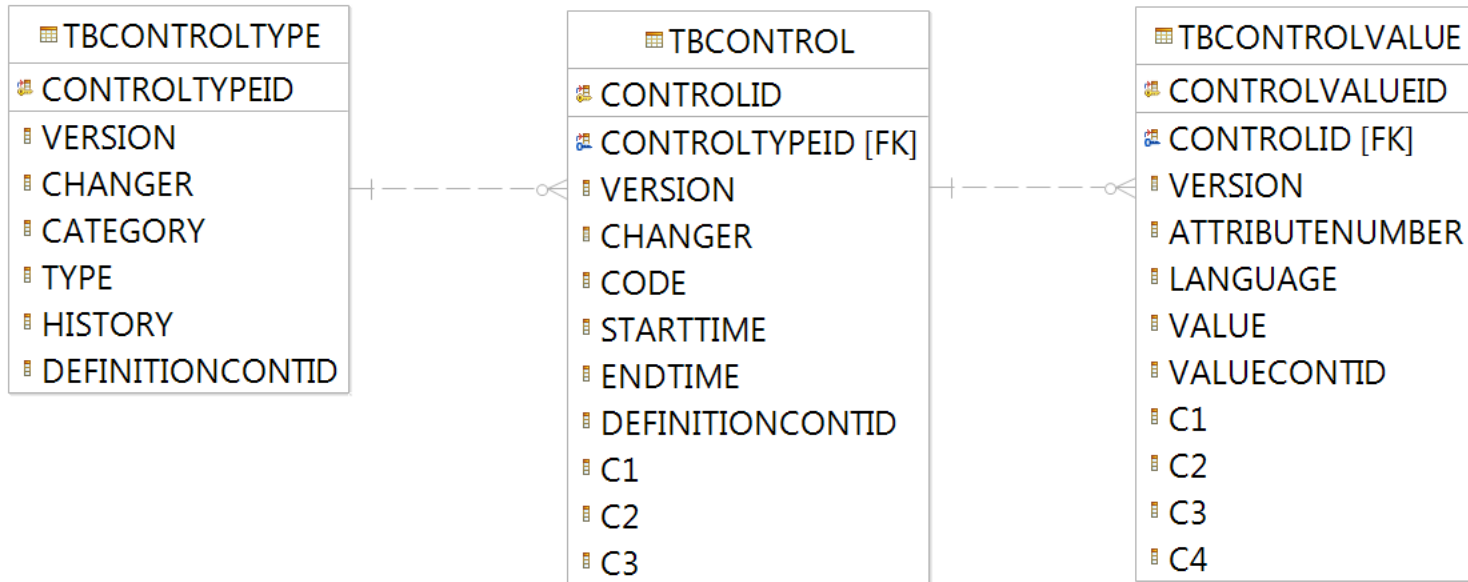

```

select value.value from test.tbcontroltype type
join test.TBCONTROL cont on cont.controltypeid = type.controltypeid and
cont.code = '404'
join test.TBCONTROLVALUE value on cont.controlid = value.controlid
and ATTRIBUTENUMBER = 5
where type.TYPE = 'ACTIVITY_CODE';
  
```

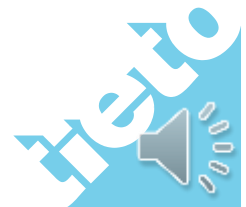

OLD STRUCTURE

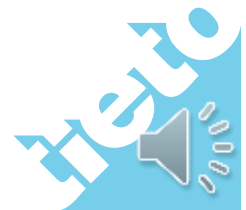
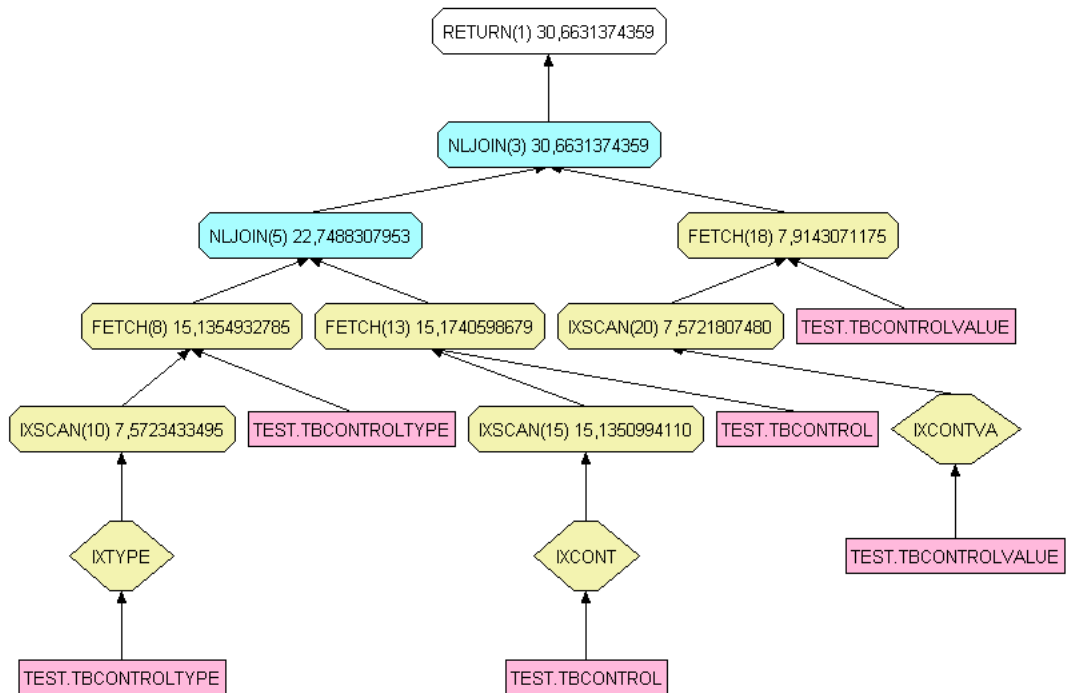

How to change PK structure

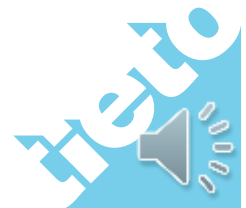
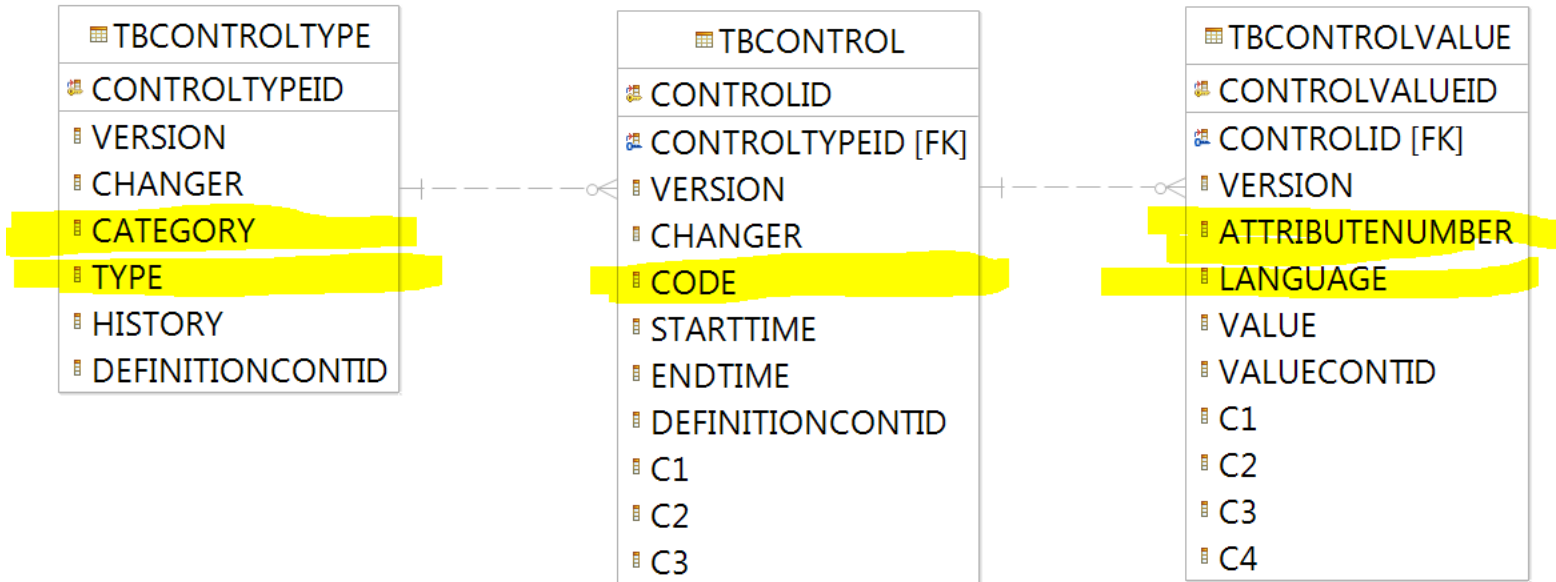

How to change PK structure

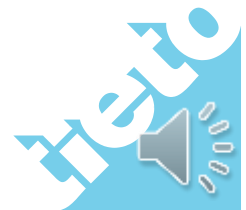
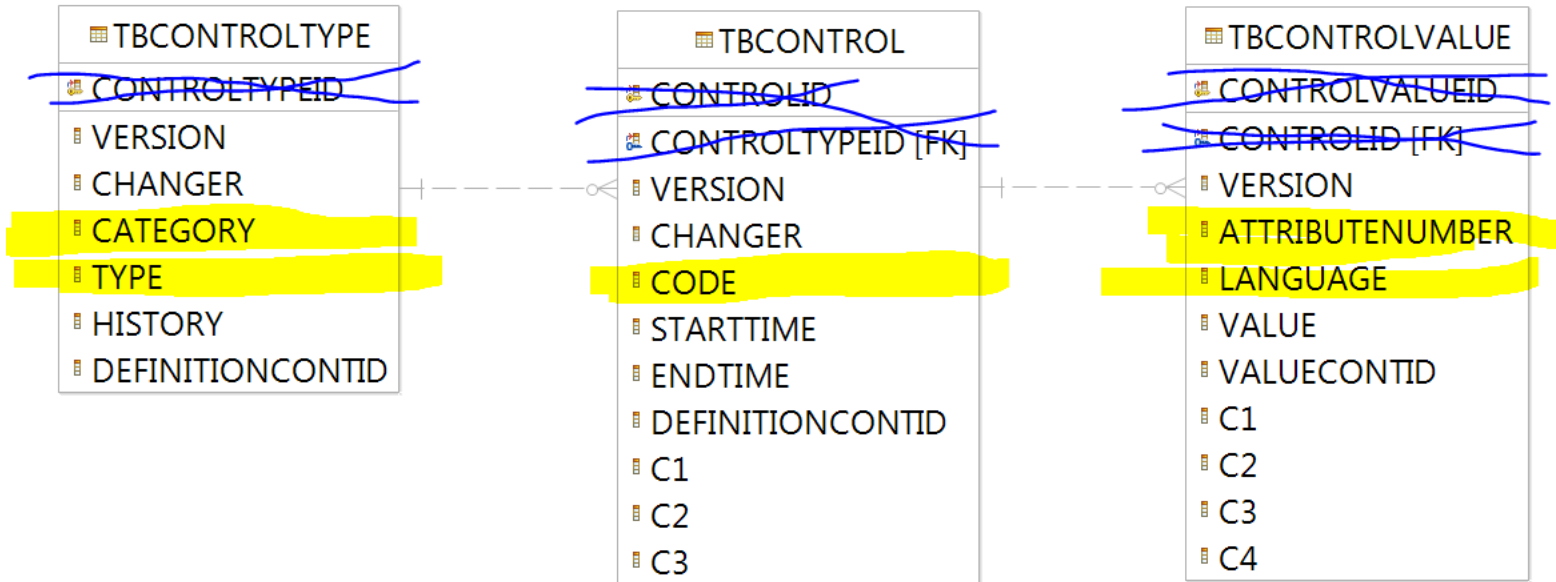

New PK structure

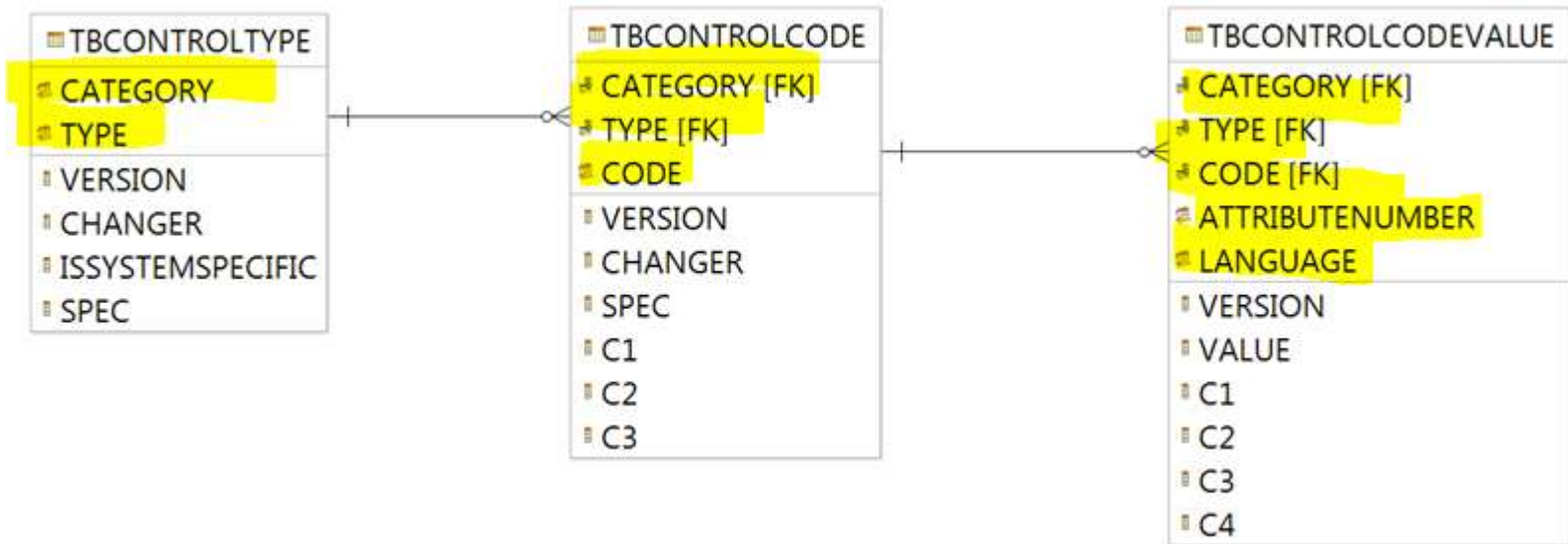

select value from lis.tbcontrolcodevalue
 where TYPE = 'ACTIVITY_CODE'
 and code = '404'
 and ATTRIBUTENUMBER = 5

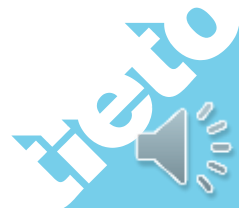

New PK structure

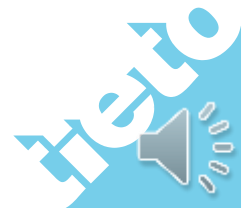
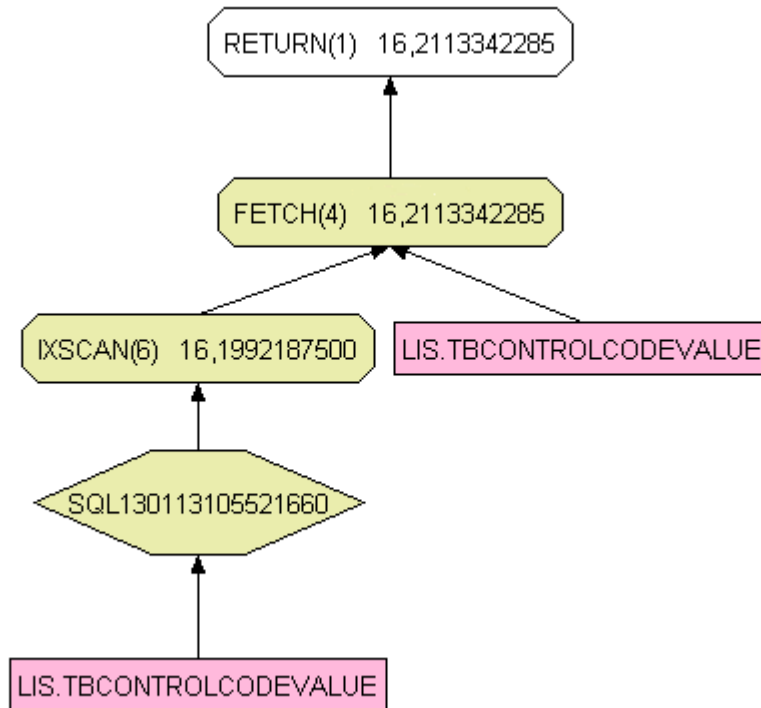

**Knowledge.
Passion.
Results.**

Mikko Larkela

Tieto,
mikko.larkela@tieto.com

